



AC Irrigation and Propagation Controllers

5004-I Four Station,
5006-I and 5006-IP Six Station



I N S T R U C T I O N M A N U A L

TABLE OF CONTENTS

INTRODUCTION	1
1. Specifications	1
2. Controller Mounting	2
3. Back-up Battery Installation	2
4. Connecting Valves and Transformer	2
5. Connecting a Master Valve or Pump Start Relay	3
6. Connecting a Rain Sensor	4
7. Programming	4
8. Setting Current Time and Day of the Week	4
9. Time Format (switching between AM/PM and 24 hour)	5
10. Valve Selection	5
11. Setting Watering Time	5
12. Selecting Watering Days	6
13. Setting a Start Time	7
14. Setting a Start Time for Cyclical or One-Time Watering	8
15. Irrigation Window in the Cyclical Program (5006-IP only)	8
16. Sensor Operation (5006-IP only)	9
17. Manual Operation	10
18. Sequential Manual Operation Via the Controller of All the Valves	10
19. Budget	11
20. "Rain Off" (Shutdown)	11
21. Valve In Operation	12
22. Valve is in Standby Mode (Wait)	12
23. No Power	12
24. Valve in Short Mode	13
25. Weak Backup Battery	13
26. No Program	13
27. Maintenance and Troubleshooting	14
28. Warranty	15
29. Technical Assistance	16

INTRODUCTION

Thank you for purchasing a DIG Controller.

Please take the time to read through the enclosed instructions and follow them step by step. If you have any questions, please call our customer service line 1-800-322-9146.

1. SPECIFICATIONS

OPERATING SPECIFICATIONS – 5004-I AND 5006-I CONTROLLER

- Programs: Independent programming for each valve
- Station run time 1 minute to 12 hours in 1 minute increments
- Watering schedule: weekly or cyclical 1 to 30 days
- Start time: 4 start times per day per valve

OPERATING SPECIFICATIONS – 5006-IP PROPAGATION CONTROLLER

- Programs: Independent programming for each valve
- Station run time 1 second up to 12 hours in 1 minute increments for each valve
- Watering schedule: weekly or cyclical
 - Weekly options: 7-day calendar
 - Cyclical options: a) intervals from 1-5 minutes in 1 minute increments
 - b) intervals from 5-15 minutes in 5 minute increments
 - c) intervals from 15-60 minutes in 15 minute increments
 - d) intervals from 1-23 hours in 1 hour increments
- Start times: Weekly mode – 4 start times per day per valve
- Cyclical mode – Up to 1 start time every minute with an option to a limit in any time during the day. Example: Start time 9AM, duration 30 seconds, interval 5 minutes, and stop time 2PM

ELECTRICAL SPECIFICATIONS

- Transformer input: 120 VAC, 60 Hz
- Station output: 24 VAC, 0.27 amps per station
- Maximum output: 24 VAC, 0.83 amps
- Battery backup: 9 volt alkaline battery (not included)

DIMENSIONS

- Height: 6" (15 cm) • Width: 4" (10 cm) • Depth: 2" (5 cm)

2. CONTROLLER MOUNTING

- Select an indoor location near a 120 VAC outlet. The location should be protected from moisture and sunlight
- Remove the mounting bracket from the back of the controller
- Place the mounting bracket slightly below eye level. Secure the bracket with #5 or 6 x 1" screws (Note: If installing on drywall, install screw anchors)
- Align controller housing with mounting bracket. Slide the controller down into position on the bracket.

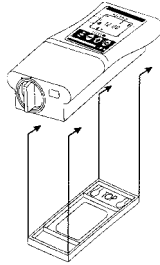

DO NOT PLUG TRANSFORMER INTO POWER SOURCE UNTIL THE CONTROLLER IS MOUNTED AND ALL VALVES HAVE BEEN CONNECTED.

3. BACK-UP BATTERY INSTALLATION

Rotate the battery compartment cover handle to the 11 o'clock position to remove the cover (see drawing). Install one 9-volt alkaline battery into terminal clip and insert into battery compartment and replace the cover. The controller display elements will briefly appear. When the display blinks "12:00", the controller is ready to program.

IMPORTANT: To replace the battery compartment cover, insert it with the handle in the "11" o'clock position to avoid possible cover guide pin breakage.

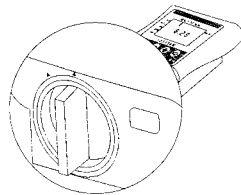

The battery is intended for irrigation program backup only. During electrical outages the program will not be erased, however, valves will not operate.

4. CONNECTING VALVES AND TRANSFORMER

1. Install control wire between valve location and controller.
2. At the valve, connect the common wire to either solenoid wire of all valves. Connect a separate wire to each of the remaining valve wires using waterproof wire splice connections.

3. Remove cover from controller to access the terminal strip area.
4. Connect valves common wire to "C" (common) and individual valve wire to appropriate valve # on the controller terminal (see Figure 1).
5. Insert transformer wire through the hole in the bottom of the controller and connect the wire to the two screws marked "AC". (Polarity does not matter.)

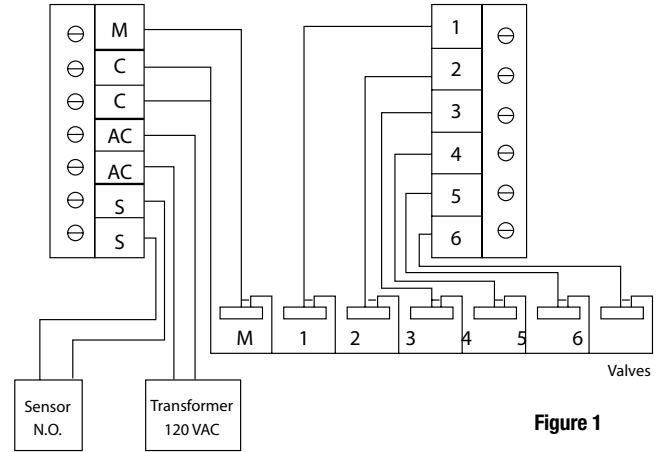

Figure 1

Do not plug transformer into power source until the controller is mounted.

5. CONNECTING A MASTER VALVE OR PUMP START RELAY

Mount the controller 10 to 15 feet away from the pump start relay and the pump.

NOTE: To operate a pump, a pump start relay must be used.

Connect either wire from pump start relay to controller terminal "M", connect other wire to the "C" (common) terminal.

Do not connect controller directly to pump start, it can damage the controller. Connecting the controller to a pump is to be performed by a qualified electrician only.

6. CONNECTING A RAIN SENSOR

An interrupt type, normally open rain sensor can be connected to the controller. The sensor connects directly to the controller sensor terminals.

Connect either wire from sensor to the two sensor terminals on the controller (see figure 1). Follow the sensor manufacturer's instructions for calibrating the sensor. See section 16 for sensor setup.

7. PROGRAMMING

DIG controllers are programmed with the aid of four buttons:



Programming step selector – used to select the desired programming mode (included clock setting mode)



Data increment button (Decrease) – Lowers the value of the selected parameter (e.g., when hours selected, from 06:00 to 05:00).



Data increment button (Increase) – Raises the value of the selected parameter (e.g., when hours selected from 06:00 to 07:00).



Next step button – used to select the parameter to be changed (hour, minute, etc.). Only a blinking parameter can be changed.



8. SETTING CURRENT TIME AND DAY OF THE WEEK

To enable the controller to operate the system at the correct times, the current time and current day of the week must first be set. Steps below explain how to set the day and time.

Press the hour digit will blink. Use the or , to set the current hour (note: use of AM and PM designations). Press the minutes digit blink, set the current minute using or . Press A blinking arrow will appear in the upper portion of the display. Use the or to move the arrow to current day. Press to proceed to the next step.

Note: If the last data entered stops flashing, press the again to resume programming.

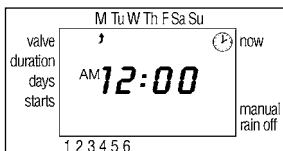

9. TIME FORMAT (SWITCHING BETWEEN AM/PM & 24 HOUR)

The default time format is AM/PM. There is also a 24 hour time format option that can be switched between the two formats.

Press several times until appears.

Press hour digit will blink. Press the and simultaneously. The clock reading switches from AM /PM to a 24 hour time display or vice versa.

Note: You can switch the time display format at any step in the programming process.

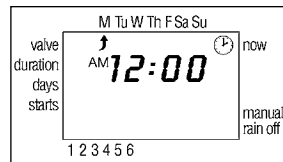

10. VALVE SELECTION

First select the desired valve, and then schedule as follows:

Press until appears.

Press . A blinking arrow appears at the bottom of the display. Move the arrow to the desired valve number by pressing or . Press to proceed to the next step.

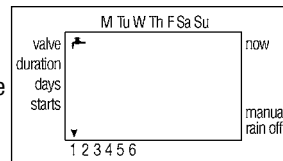

11. SETTING WATERING TIME

This setting determines the duration of time that the valve will remain open. In this option choose hour, minute or second (seconds available only on model 5006-IP propagation controller).

Press until appears. Press , the hour digit blinks. Set the desired number of hours by pressing or . Press again, the minute digits blink. Set the desired number of minutes by pressing or . Press to proceed to the next step.

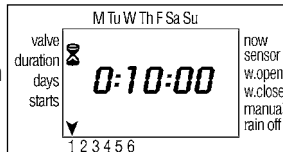

12. SELECTING WATERING DAYS

This setting determines which days the controller will operate. Choose either “A. Watering according to the days of the week” or “B. One-time irrigation” or “C. Cyclical irrigation”.

Press until appears. Press , a blinking arrow appears at the top of the display, under Monday. At this stage you can set one of three options:

- a) Watering according to the days of the week,
- b) One time only watering or cyclical watering.

A. WATERING ACCORDING TO THE DAYS OF THE WEEK.

To select a watering according to the days of the week, move the blinking arrow to the desired day of the week by pressing . Press the . The arrow under the selected day stops blinking, and in a few seconds moves one position to the right, and blinks under the next day of the week. You can select additional days of the week in the same manner.

Press to proceed to the next step.

To cancel a scheduled watering day: Press and move the flashing arrow under the selected day. Press under the selected day, the arrow will disappear and the blinking arrow will move one position to the right, and appear at the next day of the week. Cancel additional scheduled irrigation days in the same manner.

Press to proceed to the next step.

B. ONE-TIME IRRIGATION OR CYCLICAL IRRIGATION

This option is used to program the controller to operate the irrigation system one time only, for the irrigation period as set in watering time (durations).

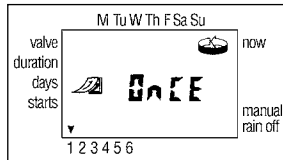

Press until appears. Press several times (for all the days of the week) until appears, and blinks **OFF** on the display.

C. CYCLICAL IRRIGATION

This option is used to program the controller to operate the system in a cyclical manner. From once a day and up to 30 days.

Press until appears. Press several times (to advance all the days of the week) until appears, and **OFF** blinks on the display. With the **OFF** blinking, press or . The number of days between watering appears on the display.

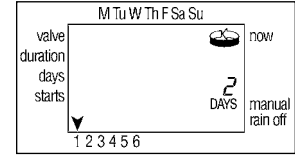

On model 5006-IP if seconds or minutes or hours are selected in Setting Watering Time the cyclical mode is also available in minutes and hours. This function is useful when the controller is used for propagation, cooling or humidity control during the hot hours of the day. For example: If the controller watering time duration is in seconds or minutes the interval can be selected from 1 minute and up to 23 hours. The user can have this program repeat by opening a window at 9 AM and closing the window at 4 PM (see #15 Irrigation Window).

13. SETTING A START TIME

In this step, up to 4 separate irrigation start times per valve can be programmed in the weekly mode (watering according to the days of the week).

Press until START I appears. The word OFF (or the last start time entered) appears. Press the word OFF blinks. Press or to set the desired start time hour (note AM and PM). Press the minute will blink. Press or to set the desired start time minute. Press to set START II and repeat the same steps for start times number 2, 3 and 4 as needed.

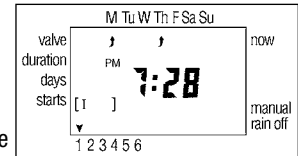

To cancel one of the start times select it by pressing . The hour digit blinks. Press the or until the word OFF appears. To program another valve, select the valve number and repeat the above steps.

14. SETTING A START TIME FOR A CYCLICAL OR ONE-TIME WATERING (WITH OPTION TO DELAY VALVE START TIME)

This option is used to set the start time (only one start time available) and the number of days to delay the start time. The number of day(s) to delay the start time will appear on the display to the right of the irrigation start time above the word “days”.

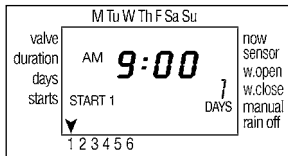

In this feature 0 days = starts today; where 1 = starts tomorrow, etc. (up to 30 days delay). Start time delay feature not available in specific days mode.

Press until START 1 appears or the last opening time entered appears on the display. Press . The hours and the AM/PM digits blink. Set the desired opening hour by pressing the or (note: AM and PM designations appear to the left of the hour digits). Press . The minute digits blink. Repeat the same step for setting the minutes and the number of days to delay watering (optional).

15. IRRIGATION WINDOW IN THE CYCLICAL PROGRAM

This option is available only on Model 5006-IP, which enables cyclical irrigation program operations to take place only during a defined part of the day (window). The irrigation window is defined as a part of a day (up to 23 hours), in the cyclical irrigation mode only.

This function is useful when the controller is used for propagation, cooling or humidity control during the hot hours of the day. For example: If the controller model 5006-IP watering time selected is 30 seconds to 5 minutes and the interval selected is from 1 to 15 minutes. The user can have this program repeat by opening a window at 9 AM and closing the window at 4 PM.

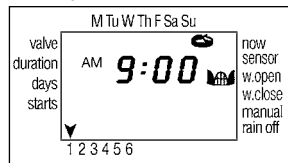

Make sure that appears on the display.

1. Press until appears on the display next to W.OPEN, with the word OFF or last OPEN WINDOW time setting displayed.
2. Press . The word OFF blinks on the display.
3. Press or to set the desired OPEN WINDOW time (pay attention to the AM/PM designation).
4. Press until appears on the display next to W.CLOSE, with the word OFF or the last close window time setting displayed.
5. Press . The 12 am blinks on the display.
6. Press or to set the desired CLOSE WINDOW time (pay attention to the AM/PM designation).

To disable the irrigation window function

1. Press until appears next to OPEN WINDOW, with the last OPEN WINDOW time setting displayed.
2. Press . The irrigation window time setting is blinking.
3. Press until OFF appears next to .

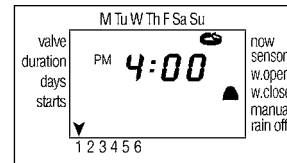

16. SENSOR OPERATION (5006-IP ON)

This option is used to add a sensor such as temperature, rain or humidity sensors.

1. Select the valve to which the sensor is to be associated.
2. Press until appears next to SENSOR.

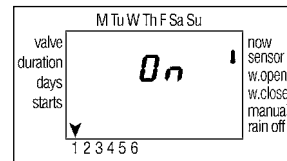
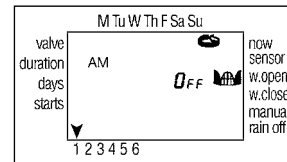

3. Press \oplus to activate the sensor in the irrigation program for the selected valve. The word "ON" appears.

* With the sensor circuit closed (i.e., the sensor detects the existence of a defined program lockout condition) the  symbol blinks on the display. In this situation, irrigation will not take place through valves associated with the sensor.

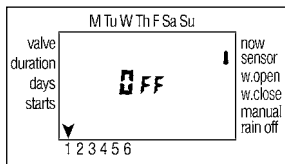

4. Press \ominus to disable the sensor. The word "OFF" appears on the display.

17. MANUAL OPERATION

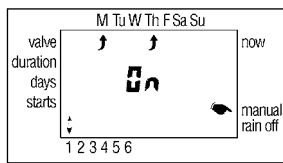
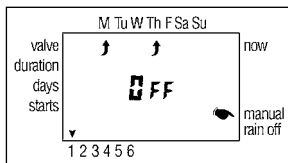

Press the  until  icon appears. Use \oplus and \ominus to open or close the valves.

- In this position, it is not possible to change the valve number. (In order to change the valve, you must return to the "valve" position.)
- If the controller is not connected to the main power supply, the word "AC OFF" will appear and the valve may not be opened.
- In manual operation, the valve will close automatically after the programmed watering time.



18. SEQUENTIAL MANUAL OPERATION VIA THE CONTROLLER OF ALL THE VALVES

This option allows all the valves to operate sequentially, one after the other (to select other valves please see Valve Selection #9 on page 4).

Press  until  appears, when no icon is blinking on the display, Press and hold down \oplus

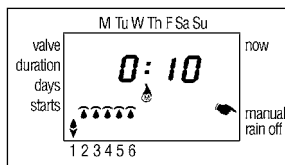



for 5 seconds. Valve number 1 will open and operate for the programmed time. When valve number 1 closes, valve number 2 opens and so forth until the last valve has opened. All the valves designated to open will blink.

At any time you can influence the process pressing \oplus to close the current valve and open the next one

Important: You can only exit this screen after all the valves have opened.

19. BUDGET

You can extend or shorten the time durations for all valves simultaneously by specifying a percentage increase or decrease for all the valves.

Press  until  appears, wait until no digit is blinking. Press \oplus / \ominus simultaneously. 00+% is displayed. Press \odot , the 00 blinks. Press \oplus or \ominus

to increase or decrease the percentage as necessary (in increments of 10% up to 90%). +% or -% are permanently display on the main  display accordingly.

Important: Budget feature cannot be assigned to an individual valve. Budget will effect all stations equally.

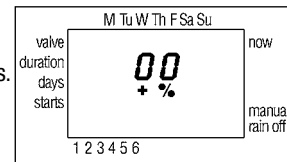



20. "RAIN OFF" (SHUTDOWN)

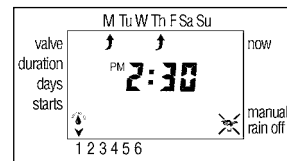

This option is used to temporarily suspend the controller operation. The irrigation schedule remains stored in the controller memory, but is not implemented until the suspension is canceled. The suspension option disables all the valves connected to the controller.



In the current time mode, press & hold the minus button \ominus until the rain-off icon  appears in the lower right corner of the display. To resume automatic operation, repeat the process – the icon will disappear.



21. VALVE IN OPERATION

The  icon will appear over the valve in operation. If the  flashes, the valve has not opened, the possibilities are:

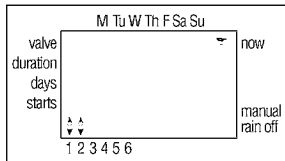
- The valve is in standby mode (WAIT). The  icon will flash once every two seconds (30 times every minute).
- Valve is in “short mode”. The  icon will flash once every 1/2 second (120 times every minute).



22. VALVE IS IN STANDBY MODE (WAIT)

When two valves are currently open, and a third valve is scheduled to open, the third valve enters wait mode. A blinking  appears above the number of the waiting valve. When one of the first two valves closes, the waiting valve opens. During “manual” operation of a waiting valve via the irrigation controller,  appears on the display, and the valve will open the moment another valve closes.

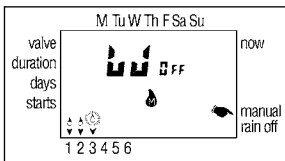

23. NO POWER

If for any reason, the controller does not receive electricity, a blinking  is displayed, indicating that the controller is not connected to AC power. The display of the icon is powered by the backup battery. The message AC OFF appears on a manual display when the irrigation controller attempts to execute an irrigation program or “manual” irrigation program, but does not receive voltage supply from the electrical mains.

The controller can be programmed in this state (with no AC voltage), but valves cannot be opened.

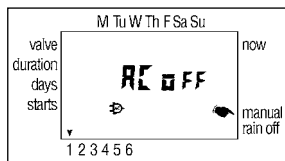

24. VALVE IN SHORT MODE

In the event of a short circuit in a valve or one of its connections, an  appears above the valve number and blinks every half a second (as distinguished from the Valve Wait mode described in Section 20). To check if the valve is indeed shorted, select the blinking valve on a “manual” screen (see Section 15).

If the valve is shorted, the word *Short* is displayed.

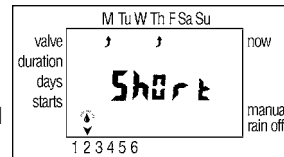

25. WEAK BACKUP BATTERY

When the battery is low, a  icon will appear on the display.

If the controller is not connected to an AC power supply, the action of replacing the battery must be completed within 30 seconds to retain the programmed data.

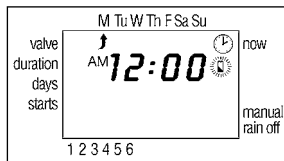

26. NO PROGRAM

During “manual” irrigation system operation via the irrigation controller, “no prog” appears on the display, meaning that no irrigation period has been set for the current valve. In this case, the irrigation controller “does not know” when to close the valve.

In this situation valve opening is disabled.

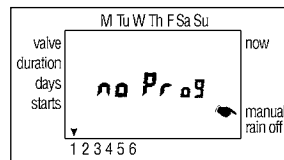

27. MAINTENANCE AND TROUBLESHOOTING

- a. Check the wiring on the controller's terminal strip and on the valves, at the beginning of a new season.
- b. The battery should be removed if the irrigation controller will not be in use for a prolonged period.

PROBLEM: Valve does not open

CAUSE: One of the following not entered: Watering time, watering days, start time

SOLUTION: Check and program as required

CAUSE: Selector on "RAIN OFF" position

SOLUTION: Cancel RAIN OFF

CAUSE: No main electric power

SOLUTION: Check transformer and socket

CAUSE: Valve or connection faulty

SOLUTION: Check the valve or replace it

PROBLEM: Valve does not close

CAUSE: Dirt or stones in the valve.

SOLUTION: Clean the valve

CAUSE: Valve was opened manually

SOLUTION: Move to automatic position

CAUSE: Valve fault (torn diaphragm)

SOLUTION: Replace valve or part

PROBLEM: Display "disappears"

CAUSE: Backup batteries are dead and no power from the transformer

SOLUTION: Check the batteries and the transformer.

28. WARRANTY

DIG CORPORATION warrants these products to be free from defects in material and workmanship for a period of three years from date of purchase. This warranty does not cover damage resulting from accident, misuse, neglect, modification, improper installation or subsection to line pressure in excess of 150 lbs. Per square inch. This warranty shall extend only to the original purchaser of the product for use by the purchaser. This warranty shall not cover batteries or any malfunction of the product due to battery failure.

The obligation of DIG CORPORATION under this warranty is limited to repairing or replacing at its factory this product which shall be returned to the factory within three years after the original purchase and which on examination is found to contain defects in material and workmanship. DIG CORPORATION SHALL IN NO EVENT BE LIABLE FOR ANY INCIDENTAL OR CONSEQUENTIAL DAMAGES OF ANY KIND; THE SOLE OBLIGATION OF DIG BEING LIMITED TO REPAIR OR REPLACEMENT OF DEFECTIVE PRODUCTS. SOME STATES DO NOT ALLOW THE EXCLUSION OR LIMITATION OF INCIDENTAL OR CONSEQUENTIAL DAMAGES, SO THE ABOVE LIMITATION OR EXCLUSION MAY NOT APPLY TO YOU.

Unattended use for prolonged periods without inspection to verify proper operation is beyond the intended use of this product, and any damage resulting from such use shall not be the responsibility of DIG CORPORATION. There are no warranties, which extend beyond the description on the face hereof. In the case of purchase of the product for use other than, for irrigation purposes, DIG CORPORATION hereby disclaims any implied warranties including any warranties of merchantability and fitness for a particular purpose. In the case of the purchase of the product for personal, family or household purposes, DIG CORPORATION disclaims any such warranties to the extent permitted by law. To the extent that any such disclaimer or implied warranties shall be ineffectual, then any implied warranties shall be limited in duration to a period of three years from the date of the original purchase for use by the purchaser. Some states do not allow limitation on how long an implied warranty lasts, so the above limitation may not apply to you.

In order to obtain performance under this warranty, the unit must be returned to the factory, along with proof of purchase indicating original date of purchase, shipping prepaid, addressed as follows:

DIG CORPORATION, 1210 Activity Drive, Vista, CA 92081. Repaired or replaced units will be shipped prepaid to the name and address supplied with the unit returned under warranty. Allow four weeks for repairs and shipping time. Repair of damaged units not otherwise within warranty may be refused or done at a reasonable cost or charge at the option of DIG CORPORATION.

This warranty gives you specific legal rights, and you may also have other rights, which vary from state to state.

29. TECHNICAL ASSISTANCE

Should you encounter any problem(s) with this product or if you do not understand its many features, please refer to this instruction manual first. If further assistance is required, DIG offers the following customer support:

TECHNICAL SERVICE USA

- DIG's Technical Service Team is available to answer questions in English and Spanish from 8:00 AM to 5:00 PM (PST) Monday-Friday (except holidays) at 800-322-9146
- Questions in English and Spanish can be e-mailed to questions@digcorp.com or faxed to 760-727-0282
- Specification documents and manuals are available for downloading in English and Spanish at www.digcorp.com



1210 Activity Drive
Vista, CA 92081-8510, USA

www.digcorp.com
email: dig@digcorp.com

26-029 REVA 040214
Printed in the USA

DIG is a Registered Service Mark of DIG Corporation

