

Model 540.000W, 540.000WS Four-Station and Model 560.000W Six-Station Battery Operated Controller

Installation, Programming and Operating Instructions

Features

- Operates up to 6 valves with Master Valve
- Independent program for each valve
- Operates on 2, 9-volt alkaline batteries
- Weekly or Cyclical programming available
- Up to four start times per day per each valve in a weekly mode
- Station run time from 1 minute to 12 hours in 1 minute increments
- Simple, four button programming
- Water budgeting from -90% to +90% in 10% increments
- Optional manual operation of one valve or sequentially of all valves
- Withstands harsh climatic conditions
- Controller can be mounted on the valve or on the valve box wall
- Rain delay up to 30 days
- 100% waterproof when submerged in water
- Operation of remote valve is up to 150' using 12 gauge wire
- Allows up to two valves to operate simultaneously
- Used only with DIG's 337-xxx dry latching solenoid and valve
- Option for rain sensor connection – Model 540.000WS



TABLE OF CONTENTS

Introduction	2
1. Controller parts identification	2
2. Battery installation	2
3. Valves or wall mounting	2
3.1 Valve mounting	2
3.2 Wall mounting	2
4. Installation	3
5. Controller installation with 337.000 solenoid	3
6. Solenoid parts identification	4
7. Installation with Model 337.075, 100, 150 and 200 DC valves	4
8. Manual-mechanical operation	5
9. Parts identification 337.075-.200	5
10. Assembly of model 336.013	5
11. Installation of model 336.013	6
12. Connecting a rain sensor to the 540.000WS	7
13. Programming	7
14. Setting current time and day of the week	7
15. Time format (switching between am/pm and 24 hour)	8
16. Valve selection	8
17. Setting the watering time (duration)	8
18. Selecting watering frequency	8
18.1 Irrigation according to the days of the week	9
18.2 One-time irrigation	9
18.3 Cyclical irrigation	9
19. Setting a start time	10
20. Setting a start time for a cyclical or one-time watering (with option to delay valve start time)	10
21. Manual operation of individual valves	10
22. Sequential manual operation via the controller of all the valves	11
23. "Rain off" (shutdown)	11
24. Budget	12
25. Wait mode	12
26. Missing a program data	12
27. Flashing low battery warning	12
28. Permanent low battery warning	13
29. Maintenance, troubleshooting and repairs	13
Recording chart	14

INTRODUCTION

Thank you for purchasing DIG's Controller. The current controller you selected is the most versatile in DIG's line of battery-operated controllers.

Please take the time to read through the enclosed instructions and follow them step-by-step. If you have any questions, please call our technical support line 1-800-322-9146.

1. CONTROLLER PARTS IDENTIFICATION

1. Top Cover
2. Controller Display
3. Bottom Cover
4. Battery Compartment Cover
5. Station Valve Wires

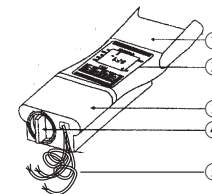

2. BATTERY INSTALLATION

To remove the battery cover, rotate the battery compartment cover handle counter clockwise to the 11 o'clock position to remove the cover (see drawing). Install 2, 9-volt alkaline batteries onto terminal clip and insert into battery compartment and reinstall the cover. When the batteries are first installed, all the icons on the display will come on briefly. Next, water droplets appear above the valve icons (numbers). Each droplet will blink momentarily in sequence down the valves, and then shut off. When the screen flashes "12:00" – the controller is now ready to be programmed.

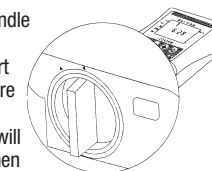

NOTE: To replace the battery compartment cover, insert it with the handle in the 11 o'clock position and then rotate the cover 1/8" to the right to avoid breaking the cover guide pin.

IMPORTANT: Connect controller station wires to solenoid wires before installing batteries! See Step 4.

3. VALVES OR WALL MOUNTING

3.1. VALVE MOUNTING

If the mounting plate [2] is attached to the controller, remove it.

1. Insert the mounting coupling [1] into the mounting plate. Align the words "top", which are stamped on both the coupling, and the plate.
2. Reattach the mounting plate. With the mounting coupling inserted, press the mounting plate against the controller's back and slide upward.

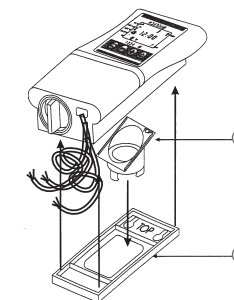

3.2. WALL MOUNTING

The controller mounting plate [2] can be mounted on a wall using two screws (not included), in which case the mounting coupling [1] is not used. Please be aware that the length of the cables limits the distance between the controller and the solenoid. (Note Maximum Wire Distance table in Step #5)

WARNING: After installation and before programming, make sure the valve(s) opens and closes hydraulically by moving the manual bleed lever from "auto" (vertical) to the "on" position (horizontal-left). If the valve stays open with lever in "auto" or "off" position (horizontal right), check the bayonet assembly for debris and verify that "O" ring #2 and puppet are in place and mounted correctly. (See Figure 4)

4. INSTALLATION

MODEL 5X0.000 controller has either four or six wires numbered up to 6 representing the valve number(s). Notice there are 2 extra wires. One wire is stamped with the letter M representing master valve, and one wire with the letter S representing the rain sensor (on Model 540.000WS only).

Connect the controller wires with valves (#1-4 for four stations and #1-6 for six stations) to the solenoid wires. Making sure that each color-coded wire (white, red, and black) from the controller will be connected to the same color-coded wires from the solenoid using a waterproof connectors. See Figure 2.

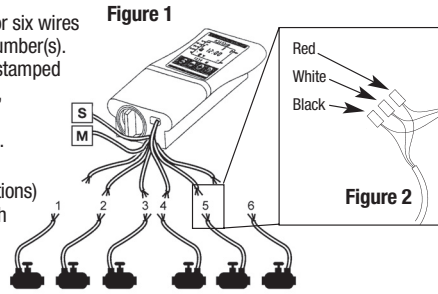

NOTE: If you install a master valve, it will open automatically with valve 1 thru 6. No special programming needed.

NOTE: Do not cut cap off of master valve wire unless using master valve.

5. CONTROLLER INSTALLATION WITH 337.000 SOLENOID

337.000 solenoid converts most 2-way AC valve solenoids with 3/4"-20 thread. Use the P00-997 adapter to convert RAIN BIRD GB, EF, DV and PE series valves.

- Shut off the mainline to the valve.
- Remove AC solenoid and plunger from the valve.
- Remove the "O" rings (if used) from the valve solenoid cavity.
 - For WEATHERMATIC valves: remove "O" ring from WEATHERMATIC solenoid and place around male threads of 337.000, bayonet adapter.
 - For RAIN BIRD valves: use model P00-997 to adapt RAIN BIRD solenoid thread to 3/4"-20 thread.
 - For IRRITROL valves: lift and remove manual bleed handle and "O" ring (if present). For 3/4" and 1" models with flow-control, use Model P00-999 extension.
 - For SUPERIOR valves: remove the SUPERIOR solenoid and "O" ring. Place one "O" ring (DIG part #30-492) inside the solenoid cavity (not included).
 - For BUCKNER valves: remove the solenoid and "O" ring. Place the BUCKNER "O" ring around the bayonet thread. Make sure manual bleed lever on the valve is closed and do not move manual bleed lever after installing DIG solenoid assembly, it can damage the bayonet and the valve will stay open.
- Install DIG solenoid adapter by turning it clockwise into female solenoid port of valve.
- After installing the solenoid adapter to the valve, remove solenoid from bayonet adapter and make sure "O" ring #1 is properly in place and install the solenoid with a 90° clockwise turn.
- Turn water supply on and pressurize the system, making sure that the valve is operating correctly (the valve will open momentarily and shut off).
- Use the manual lever on the solenoid to test the valve by turning it to the left to open the valve and to the right to close the valve (see Figure 8). If the valve opens and closes, turn lever to automatic and connect the wires from the controller to the wires from the solenoid using a waterproof connector. See Figure 2 above.
- Connect the controller wires (#1-6) to the valve solenoid wires. Make sure that each color-coded wire (white, red, and black) from the controller is connected to the same color-coded wires from the solenoid. See Figure 2 above.

MAXIMUM WIRE DISTANCE	
Wire Gauge	Maximum Run
14 AWG	100'
12 AWG	150'

6. SOLENOID PARTS IDENTIFICATION

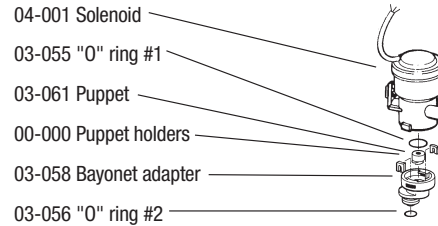

7. INSTALLATION WITH MODEL 337.075, 100, 150, AND 200 DC VALVES

The solenoid valve can be installed in-line directly to PVC pipe fittings (inlet female pipe thread, outlet female pipe thread).

NOTE: Wrap all fittings with Teflon tape. Do not use thread paste on valve as this will damage the valve and void your warranty.

IMPORTANT: Make sure flow direction arrow is pointed away from water source.

Never use the controller unit as a handle for tightening the valve to the pipe.

- Shut off the mainline to the valve.
- (See Figure 5). Before installing the valve [5] in the irrigation system flush the mainline in case any debris is present. Then remove the solenoid [1] from the valve with a 90° counter clockwise turn. Be careful not to lose the seal ("O" Ring #2) [3].
- (See Figure 5). Install the valve in the irrigation system paying attention to the correct water flow direction, as indicated by the arrow [4].
- (See Figure 5). After installing the valve [5], attach the solenoid [1] with a 90° clockwise turn. Be sure to place the seal ("O" Ring #1) [3] in its proper location.
- Turn water supply on and pressurize the system, making sure that the valve is operating correctly (the valve will open momentarily and shut off).
- (See Figure 4). Use the manual lever on the solenoid to test the valve by turning it to the left to open the valve and to the right to close the valve. If the valve opens and closes, return lever to automatic position and connect the wires from the controller to the wires from the solenoid using waterproof connectors.
- Program the controller (see programming #14).

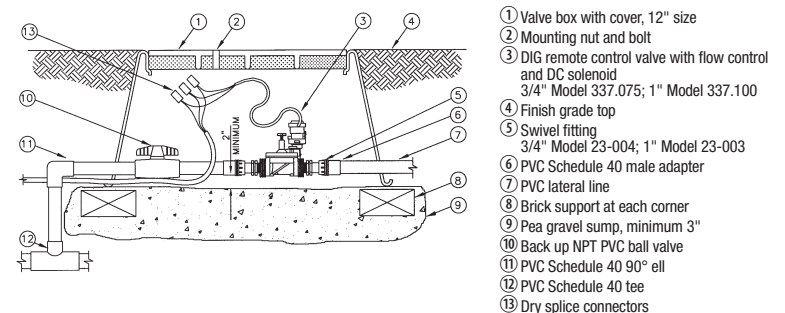

Figure 3 – 337.075 (3/4"), 337.100 (1"), 337.150 (1.5"), and 337.200 (2") Installation Detail

8. MANUAL-MECHANICAL OPERATION

The valve can be opened and closed independent of controller operation. Manual operation is useful when immediate irrigation is required, without the delay of controller programming. See Figure 4.

The 3-position manual lever is located on the side of the solenoid, and functions as follows: Open [1], Automatic Operation [AUTO], Closed [2].

IMPORTANT: For automatic operation, the valve handle must be in the middle [AUTO] position.



Figure 4

9. PARTS IDENTIFICATION 337.075-.200

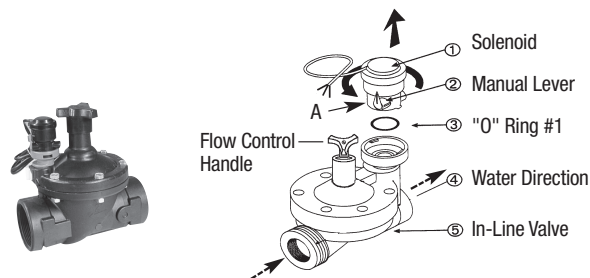

Figure 5

10. ASSEMBLY OF MODEL 336.013

The DIG valve actuator comes factory assembled to fit 3/4" CHAMPION and ORBIT manual anti-siphon brass valves. Included in the package are adaptors to fit 1" ORBIT, CHAMPION, LAWN GENIE and IRRITROL manual anti-siphon valves. See Figure 10.

NOTE: Please select proper adapter and seat washer.

10.1 ASSEMBLE PROPER ADAPTER (if required) (See Step 11)

1. Remove main screw with a pair of pliers by turning counter clockwise.
2. Remove 3/4" seat washer and then 3/4" adapter, by turning counter clockwise and pulling away.
3. Replace actuator with proper adapter and seat washer. Make sure "O" Ring #3 is in place (see Figure 6).
4. Replace main screw. Tighten firmly, but do not over tighten.

NOTE: Take care not to lose "O" Ring #3

(SEE PARTS IDENTIFICATION 336.013 NEXT PAGE)

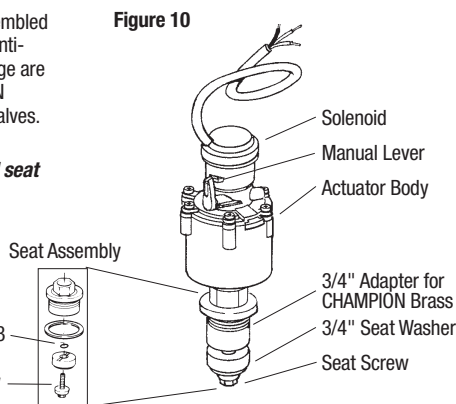
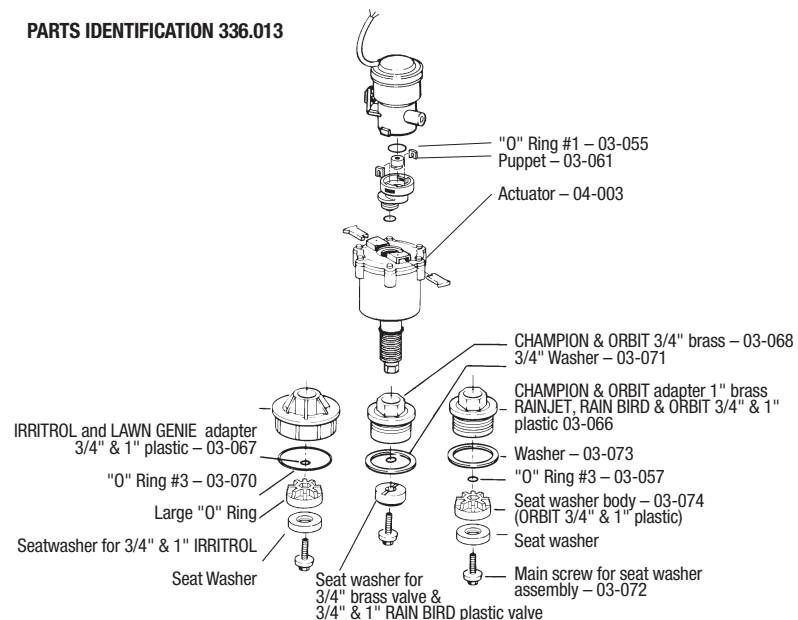

Figure 10

PARTS IDENTIFICATION 336.013



11. INSTALLATION OF MODEL 336.013

1. Shut off the mainline to the valve.
2. Remove the manual stem from the existing valve. If you are converting an anti-siphon valve, temporarily remove the anti-siphon cap (Figure 7-A).
3. Replace any existing worn washers with the new ones provided.
4. Install actuator onto valve (Figure 7-B) using a wrench tighten firmly, but do not over tighten, and mount the controller on top.
5. Rotate actuator clockwise until completely closed (Figure 7-C).
6. Turn water supply on and pressurize the system making sure that the anti-siphon valve is operating correctly (the anti-siphon valve will open momentarily and shut off).
7. Use the manual lever on the solenoid to adjust the flow on the anti-siphon valve by turning to the left to open the valve. Rotate actuator counter clockwise until all sprinklers/sprayers are working evenly.
8. Turn manual lever from the left side "on" to the right side position "off" to close the valve. If the valve opens and closes correctly, turn the lever to automatic and connect the wires from the controller to the wires from the solenoid using waterproof connectors.
9. Connect the controller wires with valve (#1-4 or #1-6) to the solenoid wires before installing batteries.
10. Program the controller (see programming #14).

NOTE: If water continues to flow, turn actuator slowly clockwise 1/4 turn. Repeat steps 5-8 if necessary.

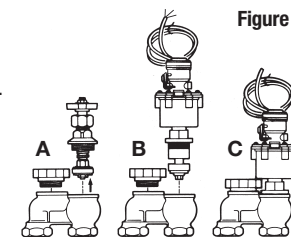
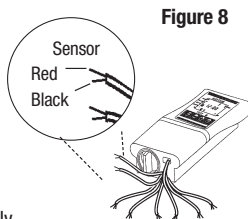

Figure 11

12. CONNECTING A RAIN SENSOR TO THE 5X0.000WS





5x0.000WS is available with an additional wire for rain sensor connection.

1. Select a rain shut off device that is "normally open" or capable of being configured to be normally open (i.e. HUNTER MINI-CLIK-Normally Open and RAIN BIRD RSD-BEX.)
2. Carefully strip the controller grey sensor wire back about six inches exposing the black and red wires inside. Then strip the tip of each wire back about 1/2".
3. Connect the controller black sensor wire to the "N.O." (normally open) wire from the sensor. Use waterproof wire connectors.
4. Connect the controller's red sensor wire to the remaining wire from the sensor.
5. Do not strip or cut wire if no sensor is used.
6. When sensor is active, a ☂ appears on the display.
7. Follow the sensor manufacturer's instructions for calibrating the sensor.



13. PROGRAMMING











DIG controllers are programmed with the aid of four buttons:

-  Programming step selector – used to select the desired programming mode (includes clock setting mode)
-  Data increment button (Decrease) – Lowers the value of the selected parameter (when hours selected are from 06:00 to 05:00)
-  Data increment button (Increase) – Raises the value of the selected parameter (when hours selected are from 06:00 to 07:00)
-  Flash button – used to select the parameter to be changed (hour, minute, etc.). Only a blinking parameter can be changed

To program the controller use the left button to move down and select the desired programming mode. The right arrow button makes the display flash. The display can only be changed when it is flashing. The plus or minus buttons change the value on the display.

14. SETTING CURRENT TIME AND DAY OF THE WEEK

To enable the controller to operate the system at the correct times, the current time and current day of the week must first be set. The steps below explain how to set the current day and time.



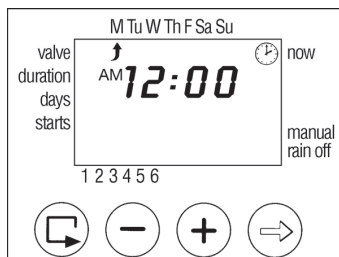

Press  and the hour digit will flash. Use the  or , to set the current hour (note: use of AM and PM designations). Press  again and the minutes digit flash. Set the current minute using  or . Press  and a flashing arrow will appear in the upper portion of the display. Use the  or  to move the arrow to current day. Press  to proceed to the next step.



Note: If the last data entered stops flashing, press the  again to resume programming.

15. TIME FORMAT (SWITCHING BETWEEN AM/PM AND 24 HOUR)

The default time format is AM/PM. There is also a 24 hour time format option. Switch between the two formats using the directions below.

Press  several times until  appears. Press  and the hour digit will flash. Press  or  simultaneously and the clock reading switches from AM /PM to a 24 hour time display or vice versa.



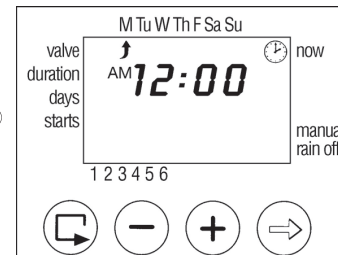

Note: You can switch the time display format at any step in the programming process.



16. VALVE SELECTION

This model operates either 1-4 or 1-6 valves depending on the model number. Each valve is independently programmed. First select the desired valve as follows:





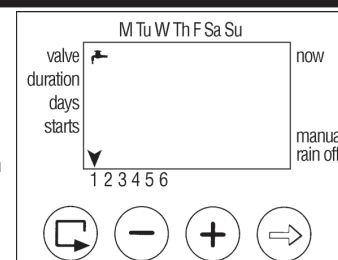



Press  until  appears.

Press  and a flashing arrow appears at the bottom of the display. Move the arrow to the desired valve number by pressing  or . Press  to proceed to the next step.



17. SETTING THE WATERING TIME (DURATION)

This setting determines the length of time that the valve will remain open.

Press  until  appears. Press  and the hour digit flashes. Set the desired number of hours by pressing  or . Press  again and the minute digit flashes. Set the desired number of minutes by pressing  or . Press  to proceed to the next step.

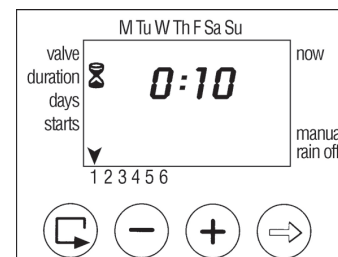

18. SELECTING WATERING FREQUENCY

This setting determines how often the controller will operate. Choose either "A" watering according to the days of the week, or "B" which can be set to water once or on a cyclical cycle. One-Time Irrigation is used to operate the controller once only. Cyclical Irrigation cycles water once every certain number of days (i.e. once every 3 days is a cyclical cycle).

Press  until  appears. Press  and a flashing arrow will appear at the top of the display. At this stage you can set one of two options:

- a) Watering according to the days of the week,
- b) One-time Irrigation (once only) or Cyclical Irrigation.

18.1 IRRIGATION ACCORDING TO THE DAYS OF THE WEEK

To select a watering schedule according to the days of the week, move the flashing arrow to the desired day of the week by pressing \leftarrow . Press the \rightarrow and the arrow under the selected day stops flashing, which locks that in as a watering day. The arrow moves one position to the right flashing under the next day of the week. Select additional days in the same manner. Press \rightarrow to proceed to the next step.

To cancel a scheduled watering day: Press \leftarrow and move the arrow under the selected day. Press \rightarrow when under the selected day and the arrow will disappear. The flashing arrow will move one position to the right and appear at the next day of the week. Cancel additional scheduled irrigation days in the same manner. Press \rightarrow to proceed to the next step.

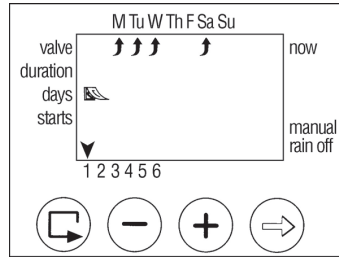

18.2 ONE-TIME IRRIGATION

This option is used to program the controller to operate the irrigation station one time only. The irrigation period is set in watering time (durations). No days are selected.

Press \rightarrow until ONCE appears. Press \leftarrow several times (for all the days of the week) until ONCE appears, and ONCE blinks on the display.

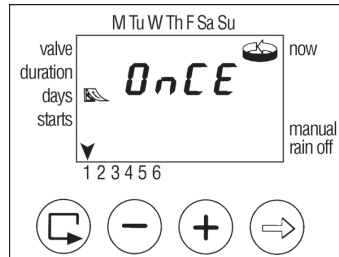

18.3 CYCLICAL IRRIGATION

This option is used to program the controller to operate the system in a cyclical manner, which is once every X amount of days. Cyclical cycles could be once every X number of days, regardless of the days of the week.

Press \rightarrow until every appears. Press \leftarrow several times (to advance through all the days of the week) until ONCE appears, and ONCE appears on the display. Press \leftarrow and ONCE will flash. Press \rightarrow or \leftarrow and the number of days between watering appears on the display.

For example, if "every 30 days" appears, watering will take place once every 30 days, for the irrigation period as set in duration. To change the number of days press \rightarrow or \leftarrow .

Press \rightarrow to proceed to the next step.

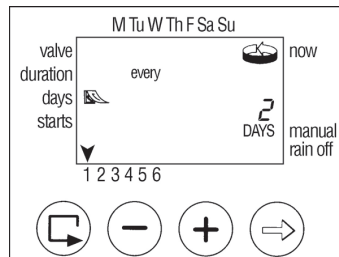

19. SETTING A START TIME

In this step, up to 4 separate irrigation start times per valve can be programmed in the weekly mode (watering according to the days of the week).

Press \rightarrow until START I appears. The word OFF (or the last start time entered) appears. Press \leftarrow and the word OFF flashes. Press \rightarrow or \leftarrow to set the desired start time hour (note AM and PM). Press \leftarrow to make the minute flash. Press \rightarrow or \leftarrow to set the desired start time minute. Press \rightarrow to set START II and repeat the same steps for start times number 3 and 4 as needed.

To cancel one of the start times select it by pressing \leftarrow . Press \leftarrow and the hour digit flashes. Press the \rightarrow or \leftarrow until the word OFF appears. To program another valve, return to the valve select mode by pressing \rightarrow until the valve appears. Then press \leftarrow and move the flashing arrow by pressing \rightarrow or \leftarrow .

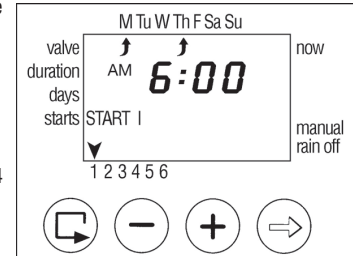

20. SETTING A START TIME FOR EITHER CYCLICAL OR ONE-TIME WATERING (WITH OPTION TO DELAY VALVE START TIME)

This program is used to pre-set the valve start time (only one start time available) and the number of days to delay the valve start time. The number of day(s) to delay option will appear on the display to the right of the irrigation start time above the word DAYS.

In this feature 0 days = program starts today; where 1 = program starts tomorrow, etc. (up to 30 days delay).

Press \rightarrow until START I appears or the last opening time entered appears on the display. Press \leftarrow to make the hours and the AM/PM digits flash. Set the desired opening hour by pressing the \rightarrow or \leftarrow (note: AM and PM designations appear to the left of the hour digits). Press \leftarrow and the minute digits flash. Repeat the same step for setting the minutes and the number of days to delay watering (optional).

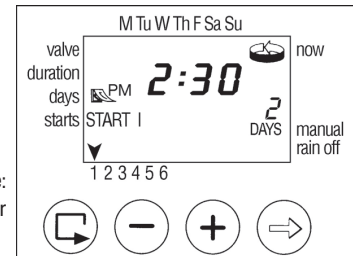

21. MANUAL OPERATION OF INDIVIDUAL VALVES

This mode turns individual valves on and off one at a time.

Press \rightarrow until ON appears. Press \rightarrow to open the valve (to select other valve please see Step #16). The word ON is displayed and a water droplet with the letter M (Master Valve) appears below ON. After 15 seconds, a count down of the remaining irrigation duration appears. To close the valve press \leftarrow . The word OFF will appear and the valve will close.

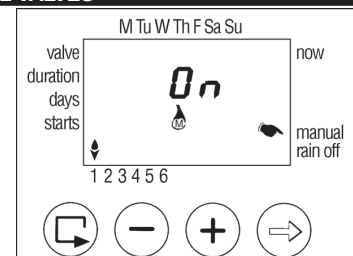

To close the valve manually before the end of the manual cycle press until ON appears again. Press to close the valve. Up to two valves can be operated simultaneously in this manner by simply repeating the above steps for the second valve.

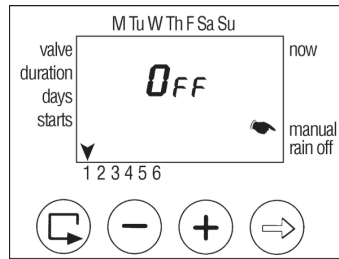

22. SEQUENTIAL MANUAL OPERATION OF ALL THE VALVES

This option allows all the valves to operate sequentially, one after the other.

Press until appears. When no icon is flashing on the display, press and hold down for 5 seconds. Valve number 1 will open and operate for the programmed time. When valve number 1 closes, valve number 2 opens and so forth until the last valve has opened.

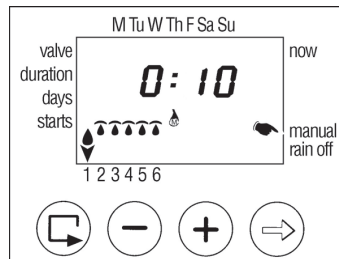

At any time you can skip to the next valve by pressing to close the current valve and open the next one.

Important: You can only exit this screen after all the valves have opened and closed.

23. "RAIN OFF" (SHUTDOWN)

This option is used to temporarily suspend the controller operation. The irrigation schedule remains stored in the controller memory, but is not implemented until the suspension is canceled. The suspension option disables all the valves connected to the controller.

Press until appears. Press and hold down for 5 seconds until appears flashing. The controller is now suspended. To return to automatic operation press until appears, and then press and hold down the until the disappears. RAIN OFF can be used while a valve has been activated.

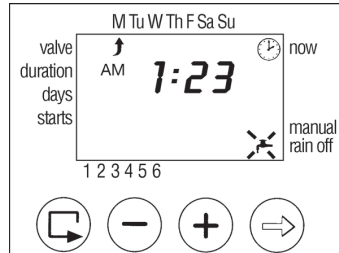

If an attempt is made to operate a valve manually while the controller has been suspended, or when a valve is meant to open sequentially, the word "rain" appears, and the valve will not open.

24. BUDGET

You can extend or shorten the time durations for all valves simultaneously by specifying a percentage increase or decrease for all the valves.

Press until appears, wait until no digit is flashing. Press and simultaneously until 00+% is displayed. Press and the 00+% flashes.

Press or to increase or decrease the percentage as desired (in increments of 10% up to 90%). The +% or -% symbols are permanently displayed on the main display accordingly.

Important: Budget feature cannot be assigned to an individual valve. Budget will effect all stations equally.

▼ ADDITIONAL DISPLAYS

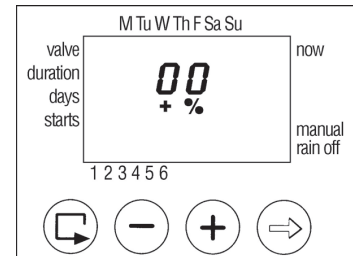

25. WAIT MODE

When two valves are currently open and a third valve is scheduled to open the third valve enters into a wait mode. A blinking appears above the number of the waiting valve. When one of the first valve two valves closes, the waiting valve opens. During "manual" operation of a waiting valve the letter "W" (Wait) appears on the display.

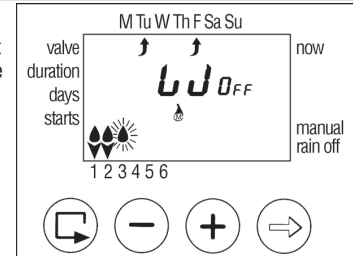

26. MISSING A PROGRAM DATA

During "manual" operation "no Prog" appears on the display (see Steps #22 and #23), indicating that no time duration has been set for the specific valve. In this case, opening of the valve is prevented.

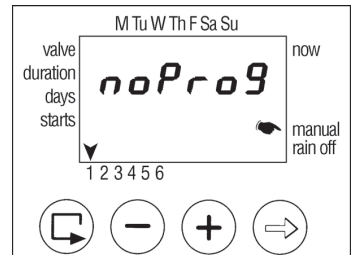

27. FLASHING LOW BATTERY WARNING

When the batteries are low, a flashing battery icon appears. In this state, the batteries still enable valve operation, but must be promptly replaced.

After replacing the batteries, press any button to resume controller operation.

Programmed data is retained if batteries are replaced within a 30 second time period.

NOTE: simply replace one battery at a time.

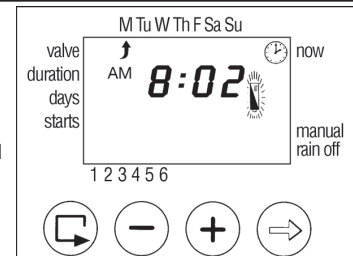

28. PERMANENT LOW BATTERY WARNING

When the batteries are low and not replaced in a timely manner, the battery icon is permanently displayed. All other display elements disappear and all valves are closed. Replace batteries promptly, and press any button to resume controller operation. Programmed data is retained if batteries are replaced within a 30 second time period.

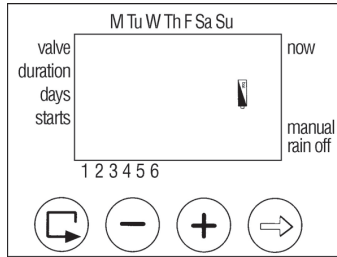

29. MAINTENANCE, TROUBLESHOOTING AND REPAIRS

MAINTENANCE

- Batteries should be removed if the irrigation controller will not be operated for a prolonged period.
- Under normal usage, batteries (alkaline) will last for one year.
- It is good operating practice to replace old batteries with new ones at the start of the irrigation season.
- Recommended operating water pressure range: 7-120 PSI. Operating pressure range 7-150 PSI.

TROUBLESHOOTING AND REPAIRS

PROBLEM

Valve does not open during automatic operation or during “manual” operation via irrigation controller

- CAUSE: Manual lever not in AUTO position
SOLUTION: Place manual lever in AUTO position
- CAUSE: Weak batteries
SOLUTION: Replace batteries
- CAUSE: One or more wire splice is faulty
SOLUTION: Check and repair wire splices

PROBLEM

No display

- CAUSE: Weak batteries
SOLUTION: Replace batteries

PROBLEM

Valve does not close despite clicks heard during activation

- CAUSE: Manual Lever not in AUTO position
SOLUTION: Place Manual Lever in AUTO position
- CAUSE: O-Ring #2 is missing between the valve and the valve coupling
SOLUTION: Install a new O-Ring #2
- CAUSE: Outlet flow may be too low (minimum flow .5 GPM or 30 GPH)
SOLUTION: Increase flow rate by adding drip emitters or micro sprinkler
- CAUSE: Valve is installed backwards
SOLUTION: Reverse valve
- CAUSE: Solenoid orifice is blocked
SOLUTION: Flush and clear port
- CAUSE: Puppet is missing
SOLUTION: Replace puppet
- CAUSE: One or more wire splice is faulty
SOLUTION: Check and repair wire splices

PROBLEM

Water leakage from the solenoid-valve coupling connection

- CAUSE: O-Ring #1 is missing (see figure 5, item 2)
SOLUTION: Install a new O-Ring #1

PROBLEM

Valve does not close completely

- CAUSE: Foreign matter is stuck in diaphragm
SOLUTION: Remove bonnet and diaphragm and clean diaphragm
- CAUSE: Diaphragm is torn or damaged
SOLUTION: Replace diaphragm

SAVE FOR YOUR RECORDS

Valve No.	Valve Location	Irrigation Program		Irrigation Duration (minutes, hours)	Daily Start Times			
		Weekly	Cyclical		1	2	3	4
1		M, Tu, W, Th, F, Sa, Su						
2		M, Tu, W, Th, F, Sa, Su						
3		M, Tu, W, Th, F, Sa, Su						
4		M, Tu, W, Th, F, Sa, Su						
5		M, Tu, W, Th, F, Sa, Su						
6		M, Tu, W, Th, F, Sa, Su						

31. DIG CORPORATION 3 YEAR WARRANTY

DIG CORPORATION warrants these products to be free from defects in material and workmanship for a period of three years from date of purchase. This warranty does not cover damage resulting from accident, misuse, neglect, modification, improper installation or subjection to line pressure in excess of 150 lbs. per square inch. This warranty shall extend only to the original purchaser of the product for use by the purchaser. This warranty shall not cover batteries or any malfunction of the product due to battery failure. The obligation of DIG CORPORATION under this warranty is limited to repairing or replacing at its factory this product which shall be returned to the factory within three years after the original purchase and which on examination is found to contain defects in material and workmanship. DIG CORPORATION SHALL IN NO EVENT BE LIABLE FOR ANY INCIDENTAL OR CONSEQUENTIAL DAMAGES OF ANY KIND; THE SOLE OBLIGATION OF DIG BEING LIMITED TO REPAIR OR REPLACEMENT OF DEFECTIVE PRODUCTS. SOME STATES DO NOT ALLOW THE EXCLUSION OR LIMITATION OF INCIDENTAL OR CONSEQUENTIAL DAMAGES, SO THE ABOVE LIMITATION OR EXCLUSION MAY NOT APPLY TO YOU.

Unattended use for prolonged periods without inspection to verify proper operation is beyond the intended use of this product, and any damage resulting from such use shall not be the responsibility of DIG CORPORATION. There are no warranties which extend beyond the description on the face hereof. In the case of purchase of the product for use other than for irrigation purposes DIG CORPORATION hereby disclaims any implied warranties including any warranties of merchantability and fitness for a particular purpose. In the case of the purchase of the product for personal, family or household purposes DIG CORPORATION disclaims any such warranties to the extent permitted by law. To the extent that any such disclaimer or implied warranties shall be ineffectual, then any implied warranties shall be limited in duration to a period of three years from the date of the original purchase for use by the purchaser. Some states do not allow limitation on how long an implied warranty lasts, so the above limitation may not apply to you.

In order to obtain performance under this warranty, the unit must be returned to the factory, along with proof of purchase indicating original date of purchase, shipping prepaid, addressed as follows:

DIG CORPORATION, 1210 Activity Drive, Vista, CA 92083. Repaired or replaced units will be shipped prepaid to the name and address supplied with the unit returned under warranty. Allow four weeks for repairs and shipping time. Repair of damaged units not otherwise within warranty may be refused or done at a reasonable cost or charge at the option of DIG CORPORATION.

This warranty gives you specific legal rights, and you may also have other rights which vary from state to state.

CUSTOMER SERVICE:

1-800-322-9146 FAX: 760-727-0282



1210 Activity Drive
Vista, CA 92081-8510, USA

Website:
<http://www.digcorp.com>
e-mail: dig@digcorp.com

120306 DIG CORP 26-039
Printed in the USA

